

# Curriculum

## Arthur and Tania Go to Pirate School

Grade: Kindergarten and 1<sup>rst</sup>

# ARTHUR AND TANIA GO TO PIRATE SCHOOL

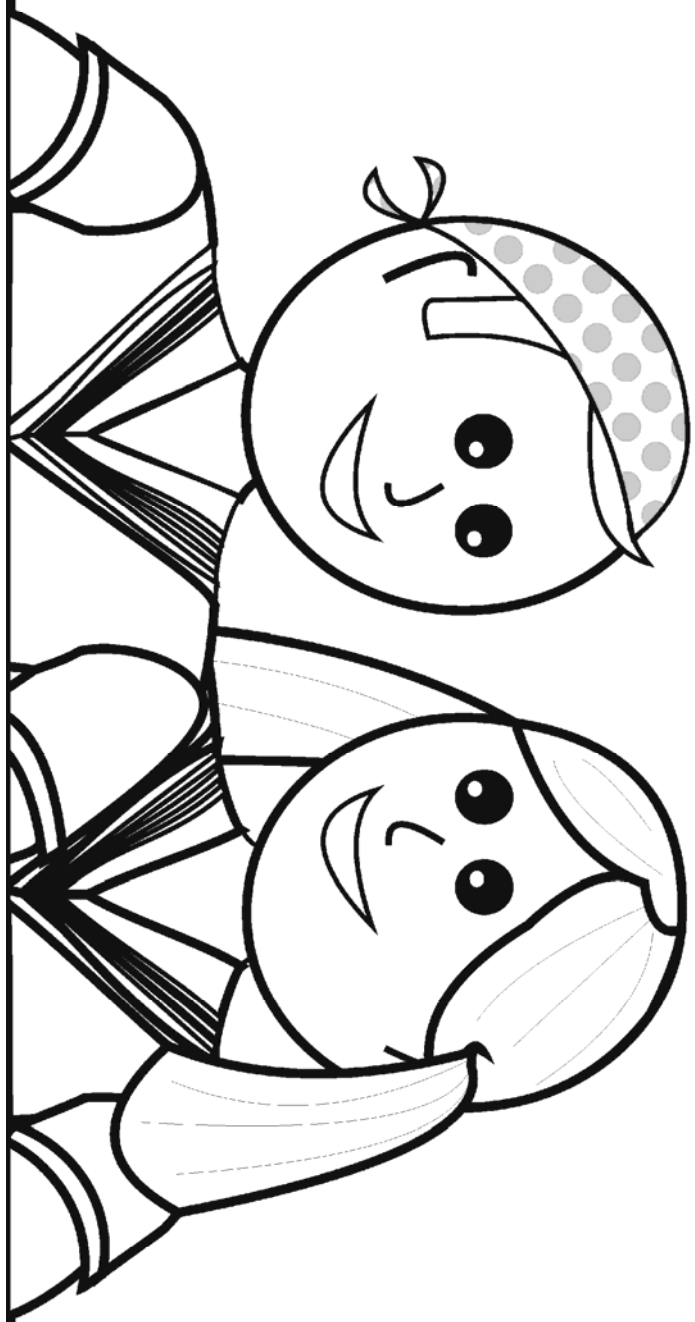

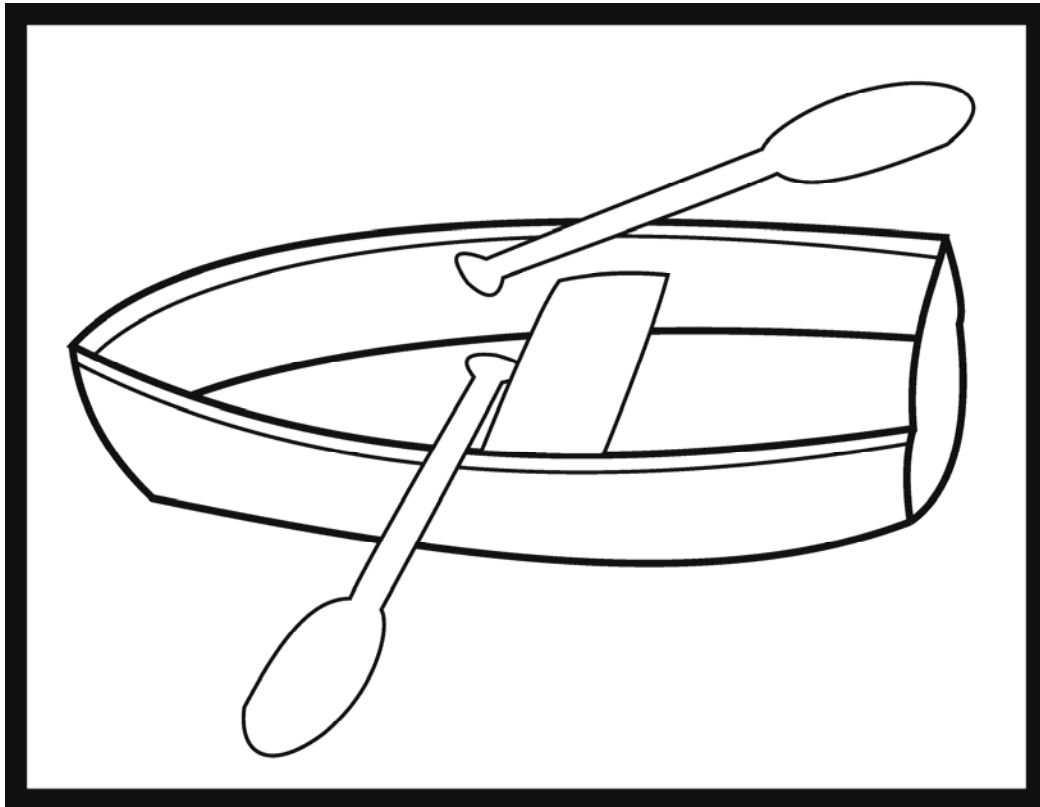

row boat

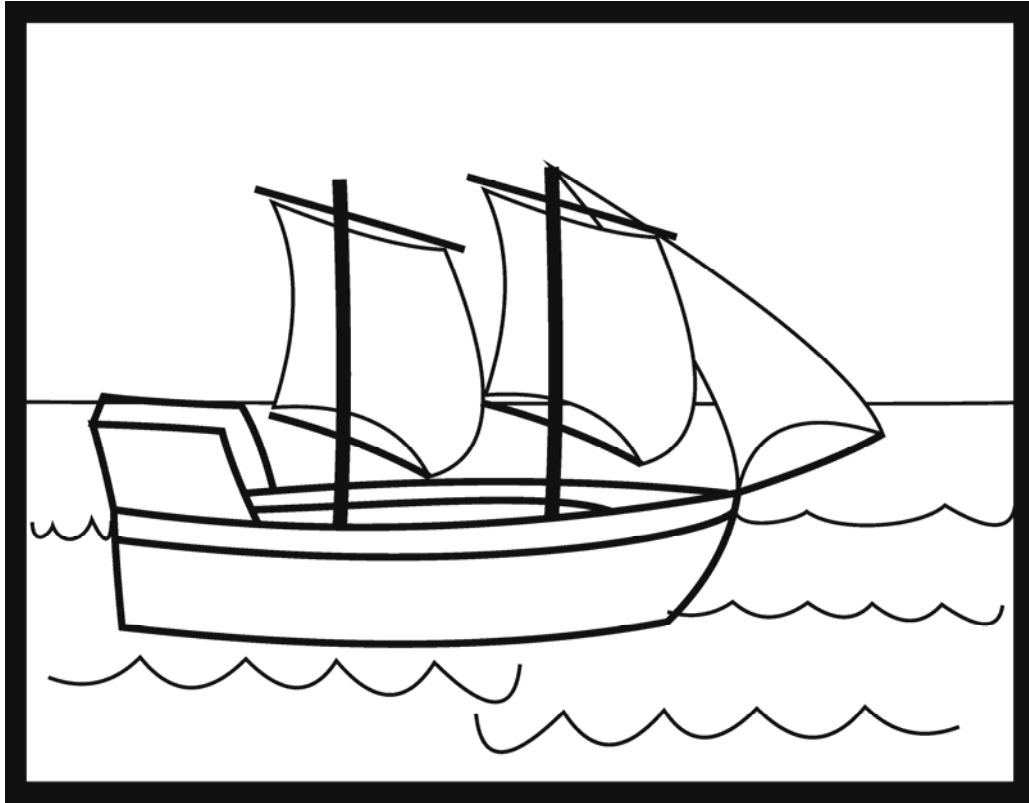

ship

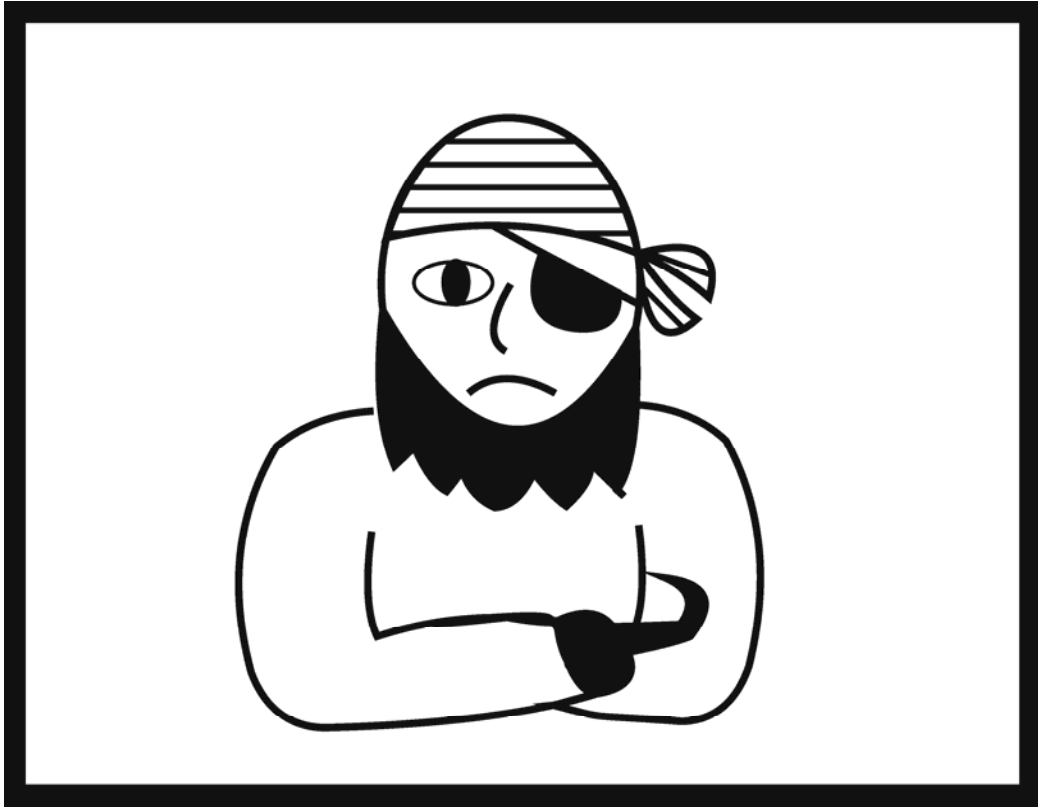

pirate

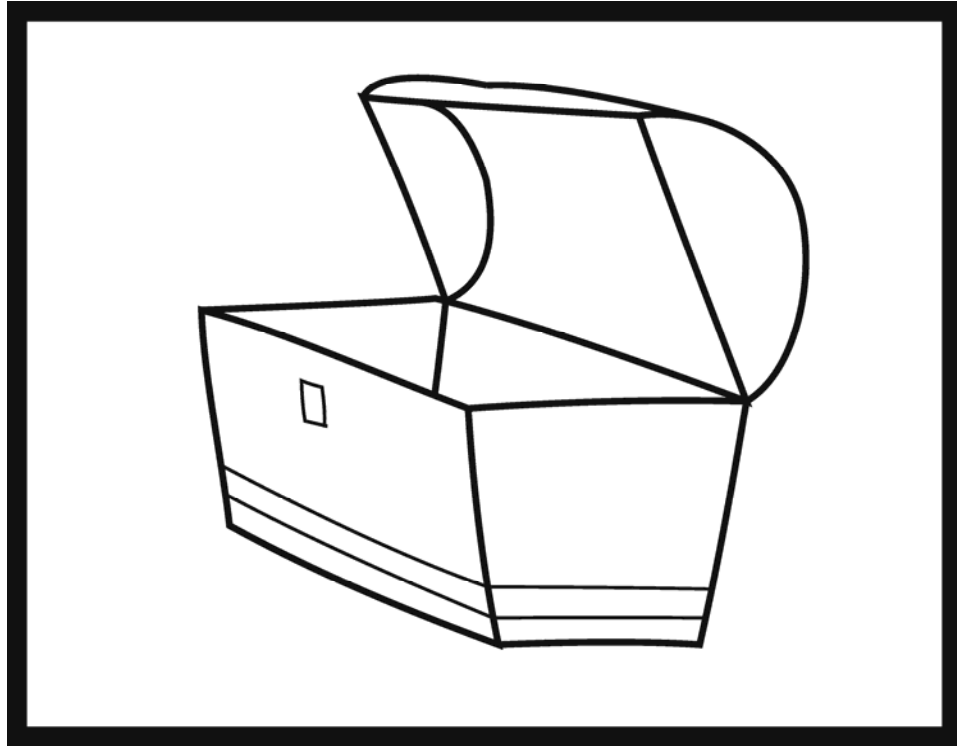

chest

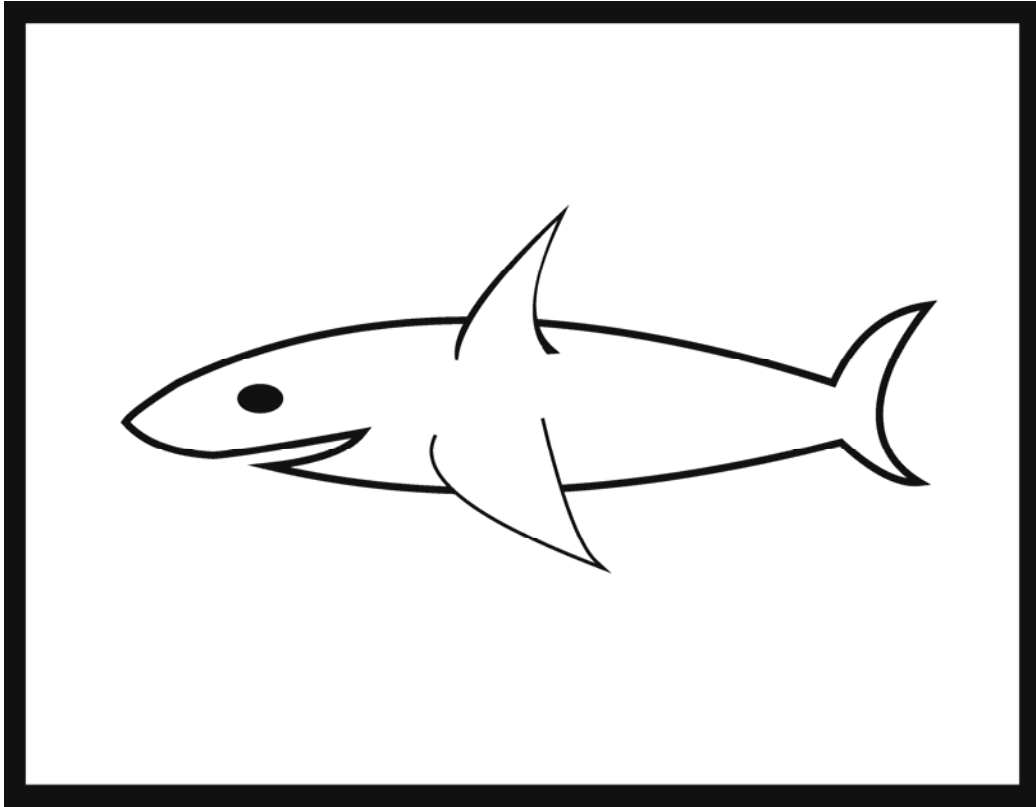

shark

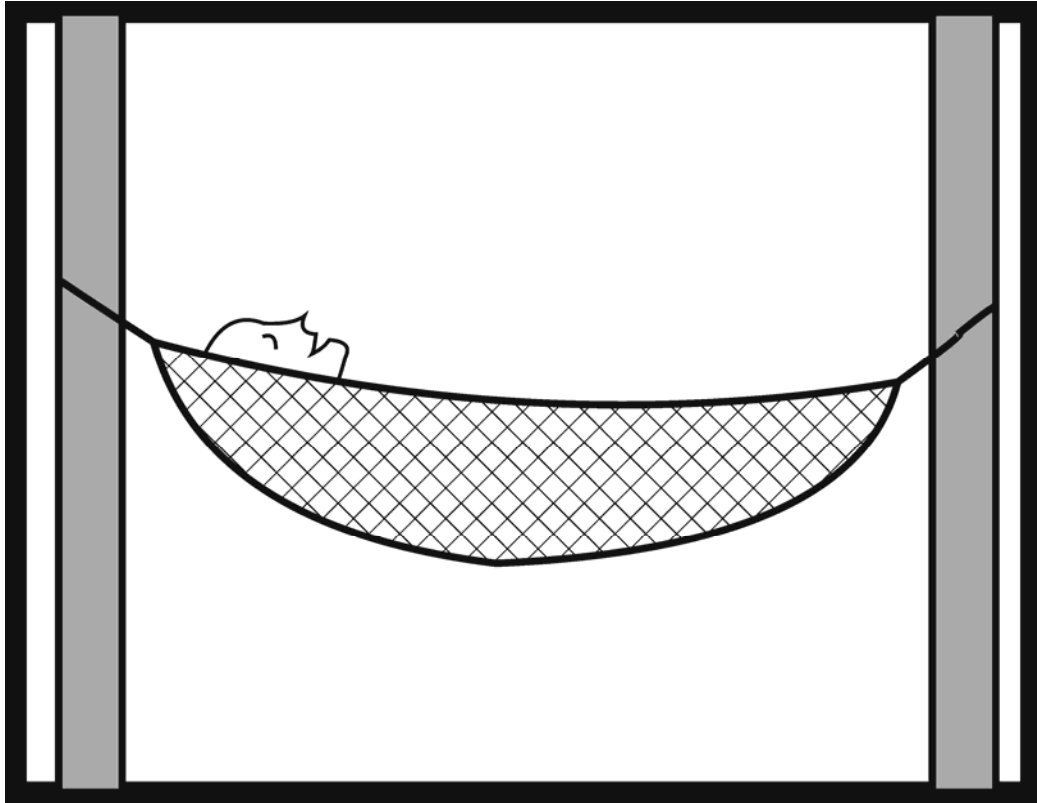

hammock



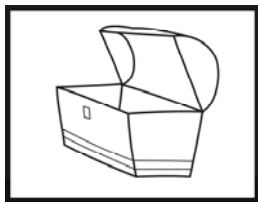

chest

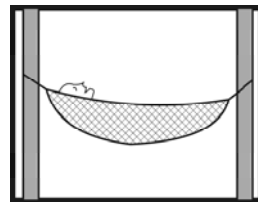

hammock



pirate

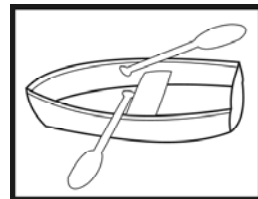

row boat

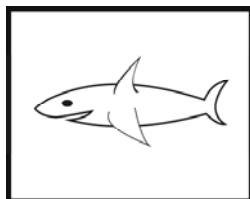

shark

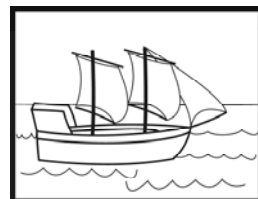

ship

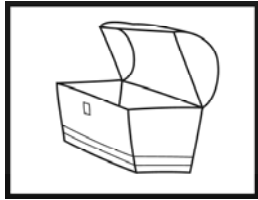

chest

---

---

---

---

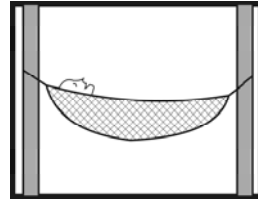

hammock

---

---

---

---



pirate

---

---

---

---

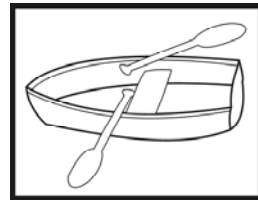

row boat

---

---

---

---

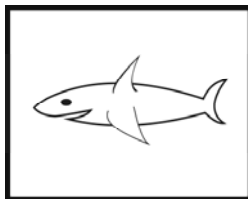

shark

---

---

---

---

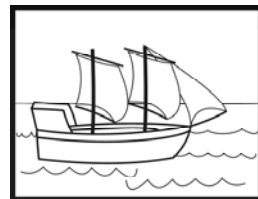

ship

---

---

---

---

# Crossword

1.

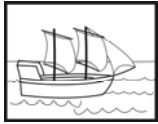

2.

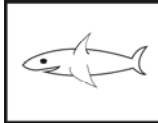

3.



4.



5.

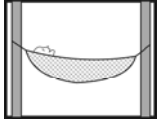

6.

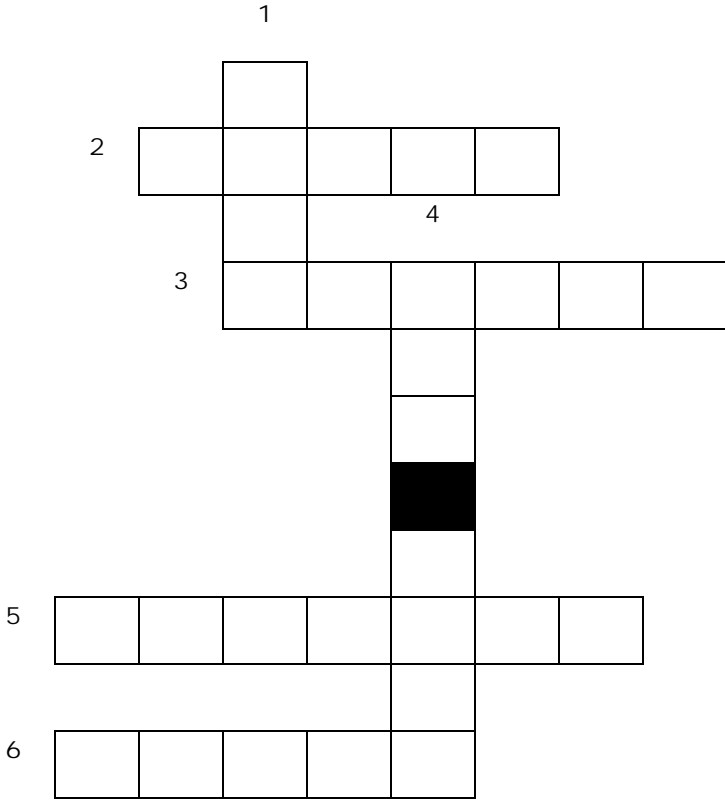
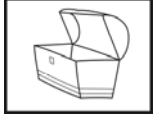

# Fill the text

Arthur sleeps in a \_\_\_\_\_.

The \_\_\_\_\_ eats fishes.

Tania found a \_\_\_\_\_.

The \_\_\_\_\_ has a hook in his hand.

The \_\_\_\_\_ goes on the sea.

To go on the island, I take a \_\_\_\_\_  
\_\_\_\_\_.

# Fill the text

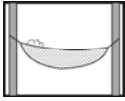
Arthur sleeps in a  \_\_\_\_\_.

The  \_\_\_\_\_ eats fishes.

Tania found a  \_\_\_\_\_.

The  \_\_\_\_\_ has a hook in his hand.

The  \_\_\_\_\_ goes on the sea.

To go on the island, I take a  \_\_\_\_\_  
\_\_\_\_\_.