

Curriculum

Arthur et Tania
à l'école des pirates

Niveau : Maternelle et 1^{ière}

ARTHUR ET TANIA À L'ÉCOLE DES PIRATES

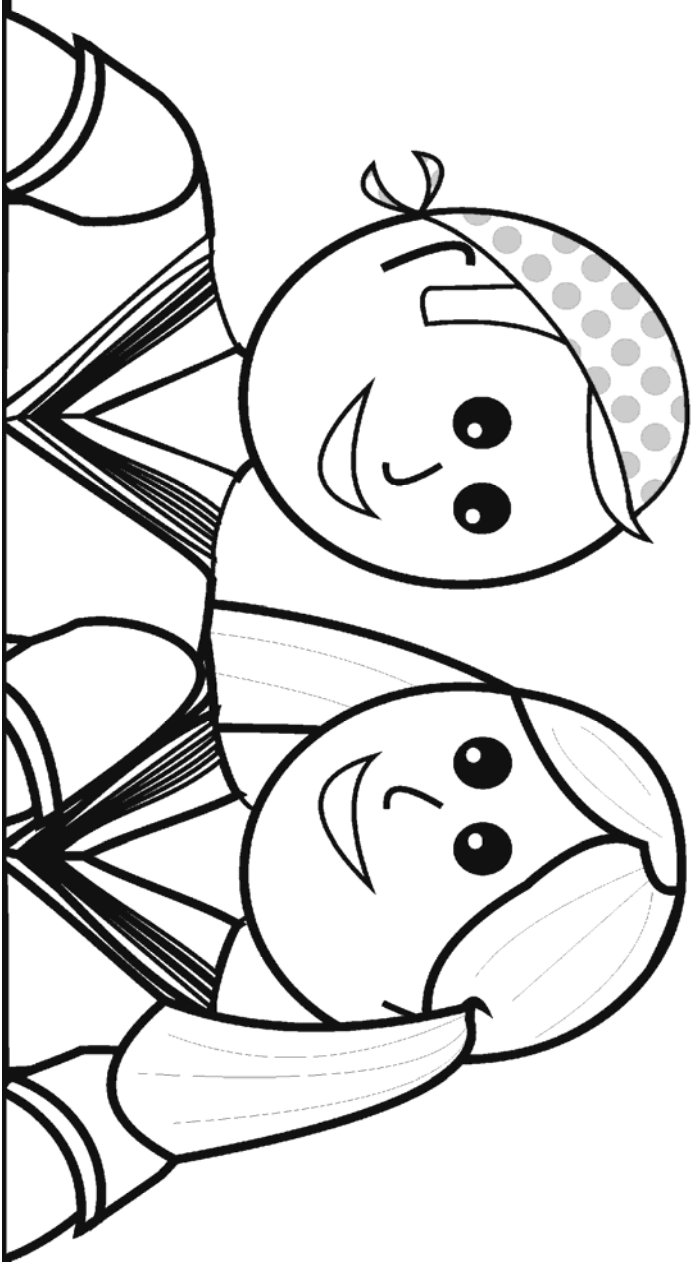

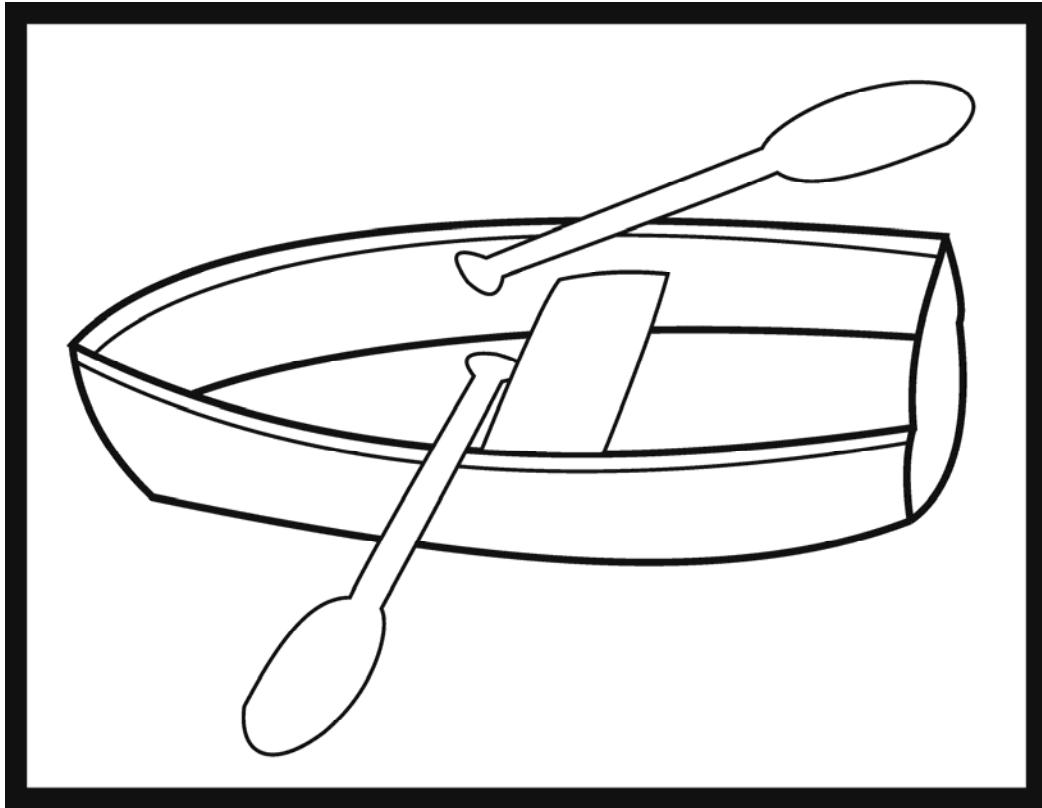

chaloupe

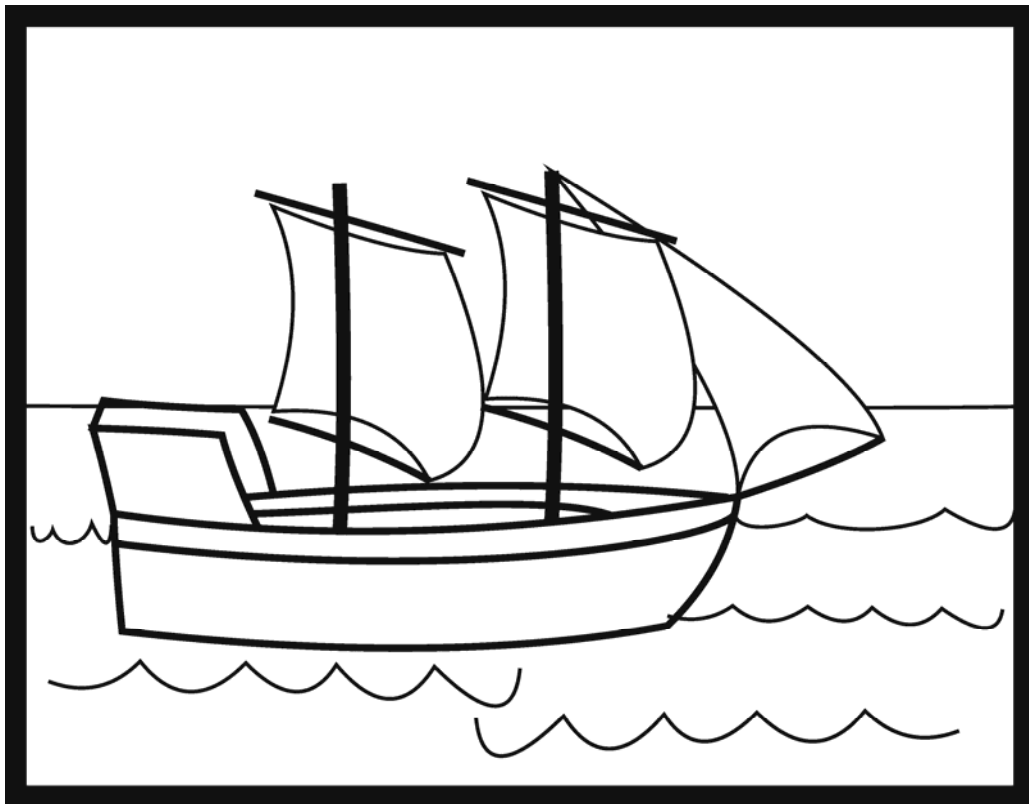

navire



pirate

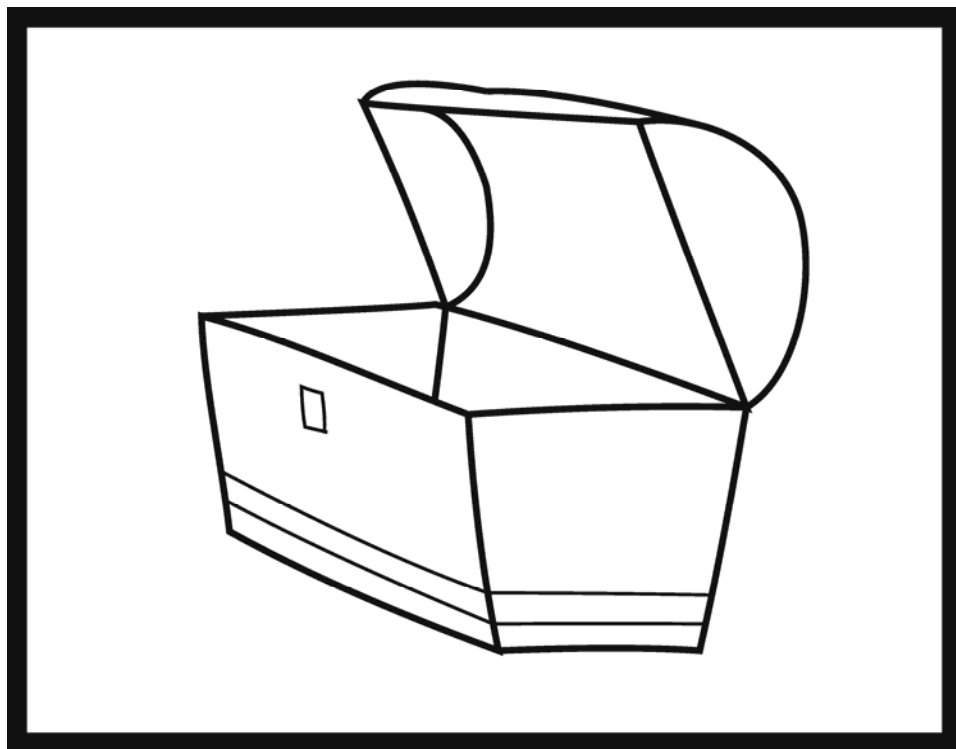

coffre

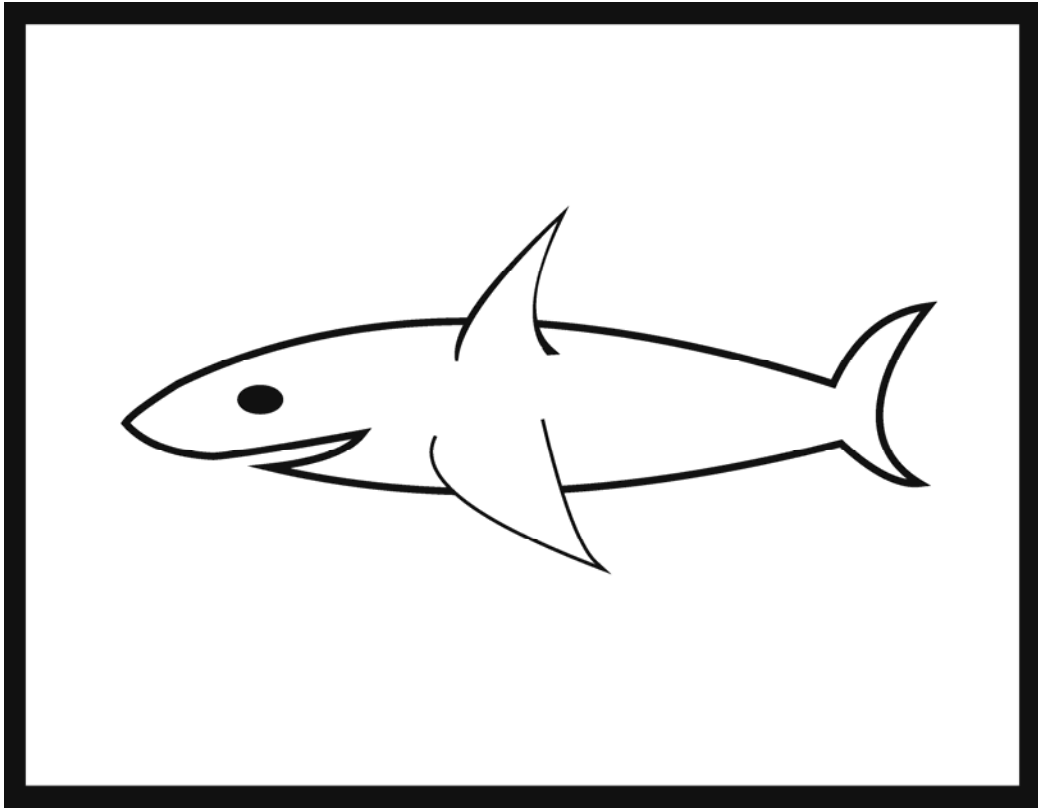

requin

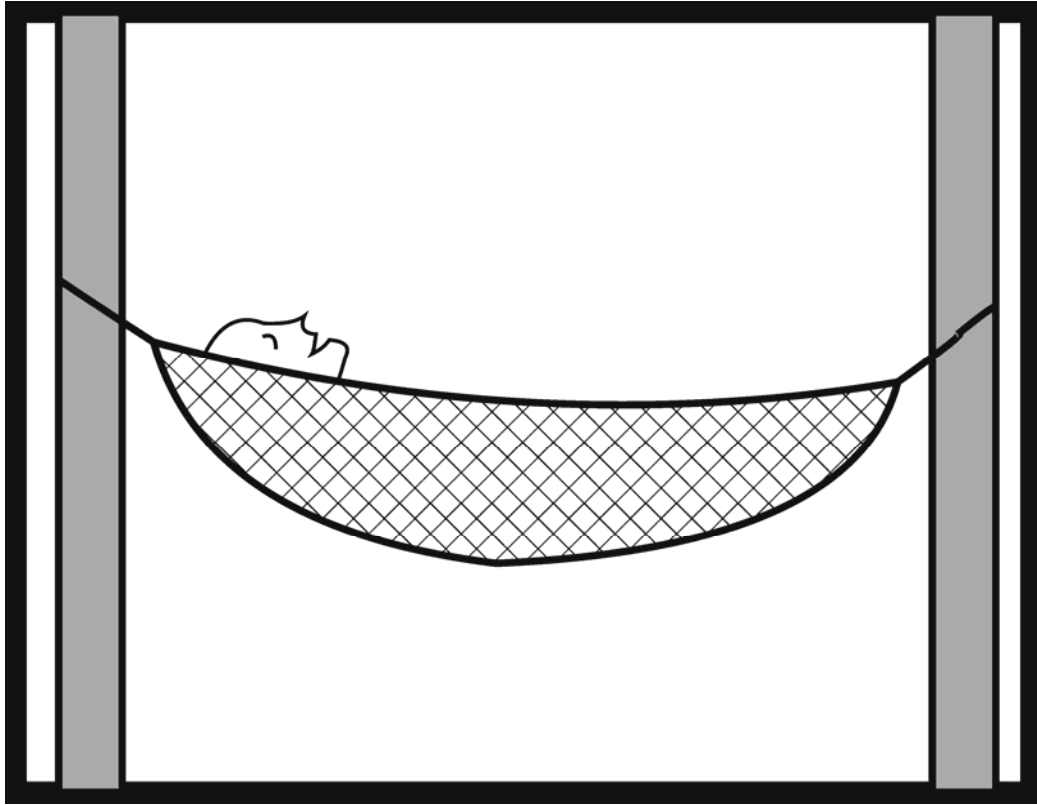

hamac

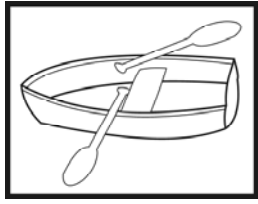

chaloupe

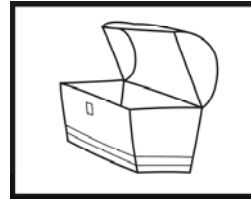

coffre

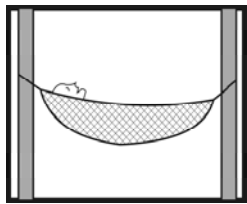

hamac

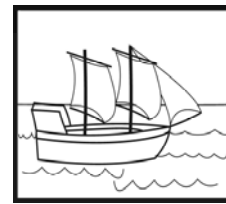

navire



pirate

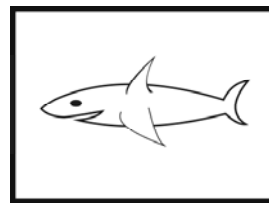

requin

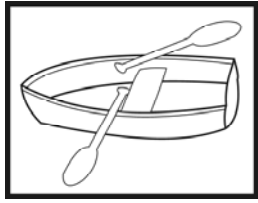

chaloupe

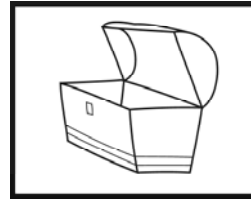

coffre

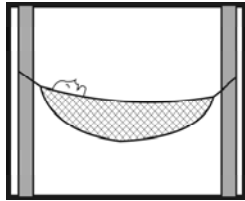

hamac

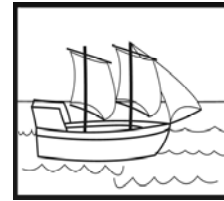

navire



pirate

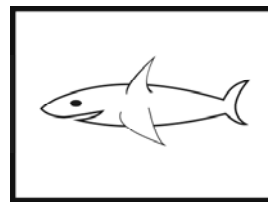

requin

Mots croisés

1.



2.

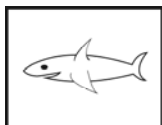

3.

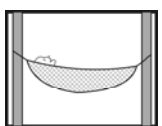

4.

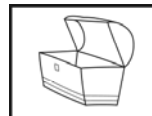

5.

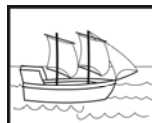

6.

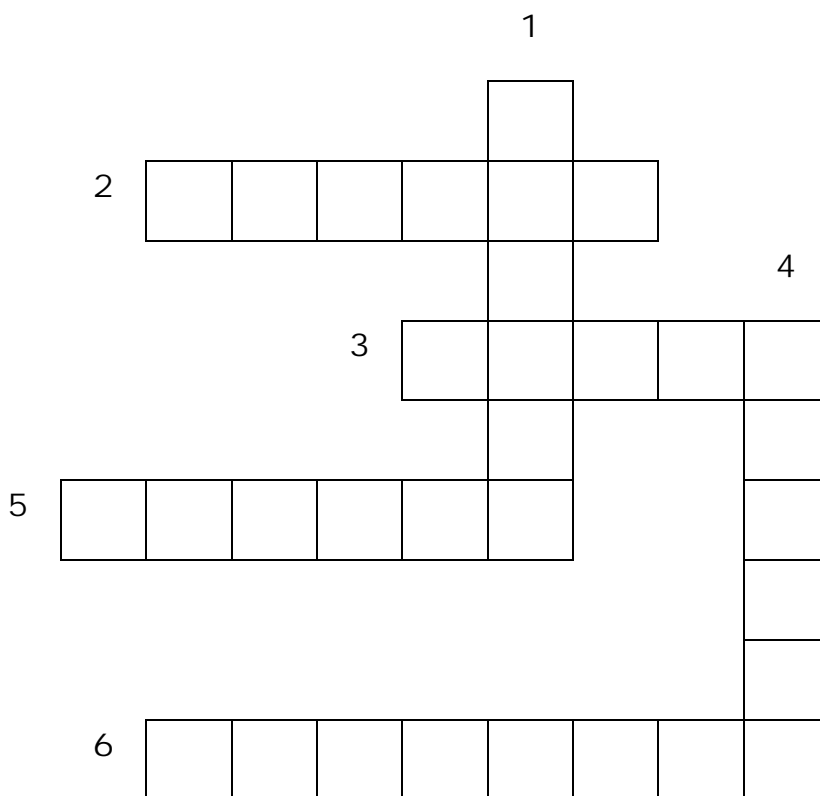
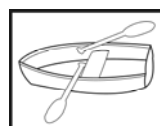

Dictée de mots

Arthur dort dans un _____.

Le _____ mange les poissons.







Tania a trouvé un _____.

Le _____ a un crochet dans la main.

Le _____ va sur la mer.

Pour aller sur l'île, je prends une _____.

Dictée de mots

- Arthur dort dans un  _____.
- Le  _____ mange les poissons.
- Tania a trouvé un  _____.
- Le  _____ a un crochet dans la main.
- Le  _____ va sur la mer.
- Pour aller sur l'île, je prends
une  _____.